

Article number: 6160401610

Description: Welding hub for taper bush type MSB
for taper bush 1610

Measures

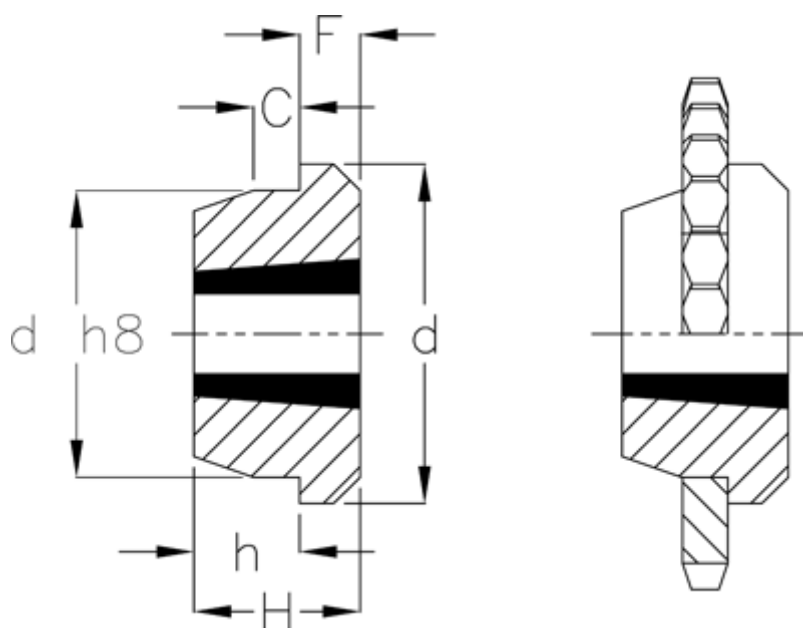

C	= 10
d	= 83
d H8	= 70
F	= 9
For taper bush = 1610	
H	= 25
h	= 16